

Figure 1

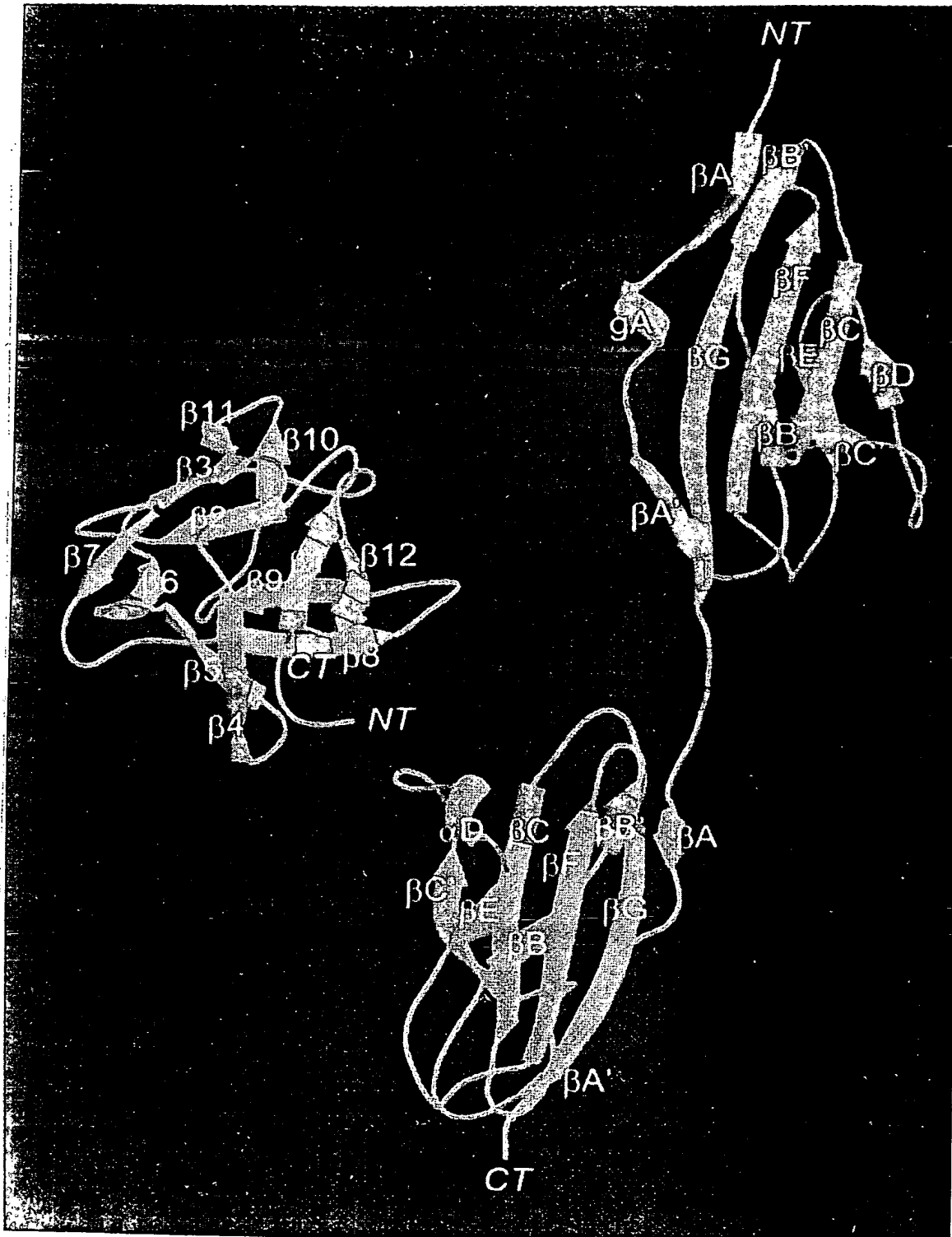
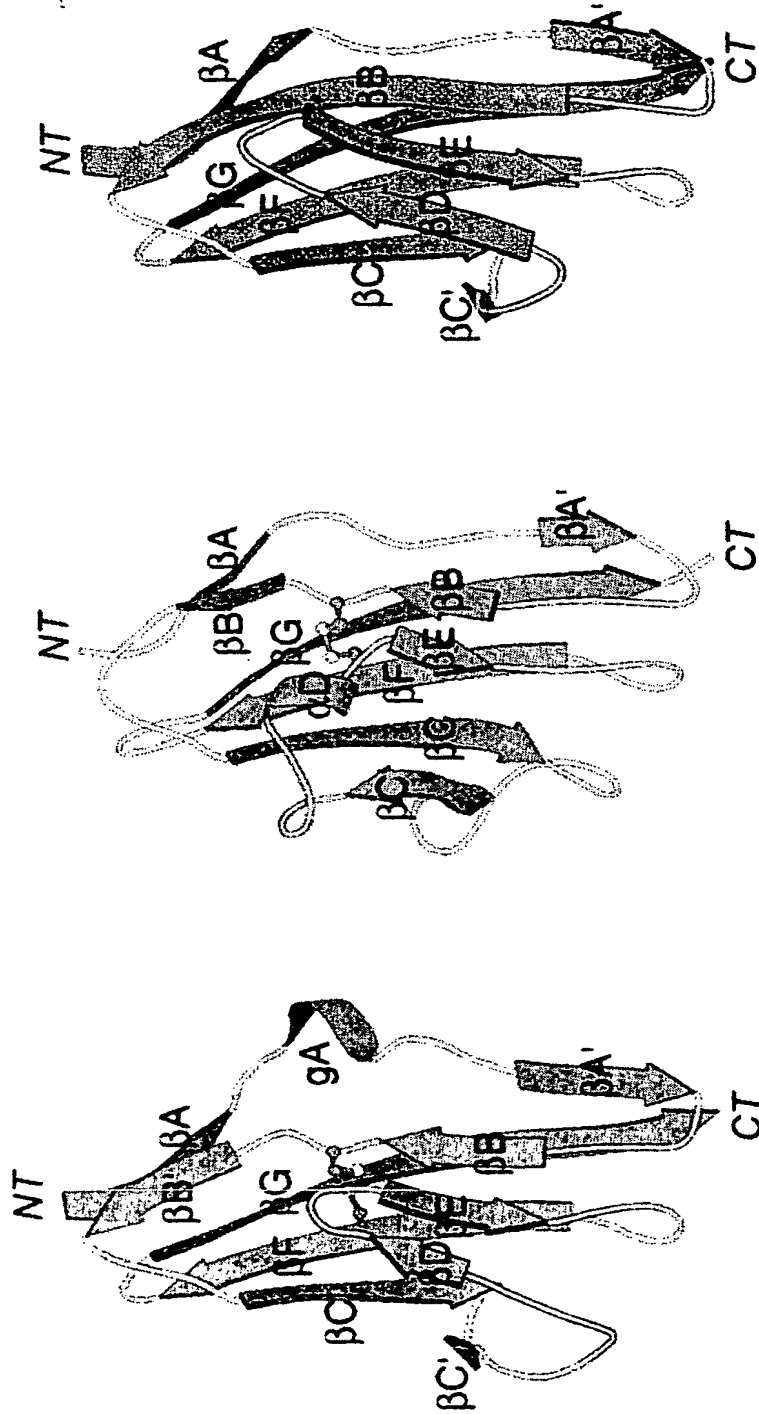

Figure 2



Telokin

FGFR1-D3

FGFR1-D2

Figure 3

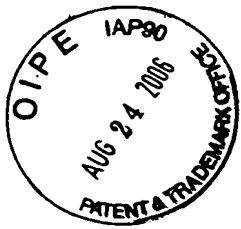

	bbba	gggA	bbbaA'	bbba	bbbe'	bbbbc	bc'
150	160	170	180	190	200		
FGFR1	MPVAPYWTSPERMEKLEAVPAAYVKFKCPSSGTPNPTLRWLKNGKFKPDE						
FGFR2	NKR.....NT.....R.....N.....R..AG.N.M..M.....QE.						
FGFR3	DTG.....R..R.D..L.....N..R.R..AA.N.T.SIS.....R..RGE.						
FGFR4	PQQ.....H.QR.....CN.....R..AA.N.T..I.....D.QA.HGEN						

	bbD	bbbe	bbbbbfff	bbbbbbsbbbg
210	220	230	240	250
FGFR1	RIGGYKVRyatWSIIMDSVVPsDKGNyTCIVENEyGSINeTYQLDvVERS			
FGFR2NQH..L..E.....V.....H.....			
FGFR3I.L.HQQ..LV.E.....R.....V..KF..RQ..T..L...			
FGFR4IRL.HQH..LV.E.....R.T..L..AV..RYN.L..L....			

	ba	baa'	bbba	bbbe'	bbbbc
260	270	280	290		
FGFR1	PbRPILQAGLPANKTVALGSNVEFMCKVYSDFQPRIQWLKHIEVNGS				
FGFR2ASTVV.GD...V.....A.....I..V.K...				
FGFR3Q.AV...D...H.....A.....V.....				
FGFR4T.AVV..D..LL.....A.....VI....				

	bbbbc'	bbbd	bbbe	bbbbbff	bbbbbbsbbg
300	310	320	330	340	350
FGFR1	RIGPDNLpYVQILKTAGVNTTDKEMEVLHLRNVSFE DAGEYTCLAGNSIGLSHSAWLTVL				
FGFR2	.Y...G...LKV..A.....I...YI...T.....I.F.....				
FGFR3	.V...GT...TV....A.....L...S.H.T.....F.....V...				
FGFR4	SF.AVGT...V...DI.SS--V...Y...A.....YQ.....				

Figure 4

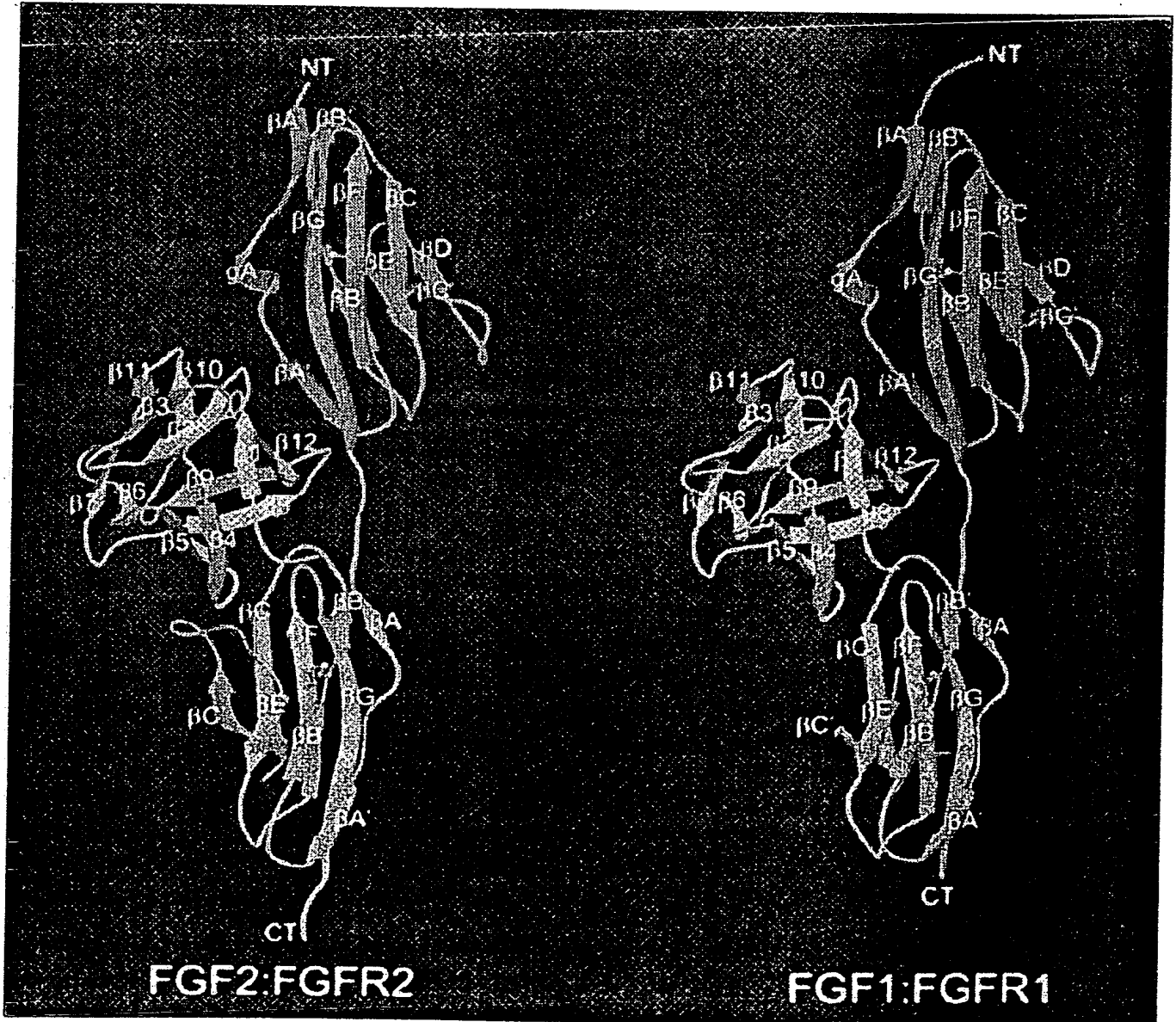

Figure 5

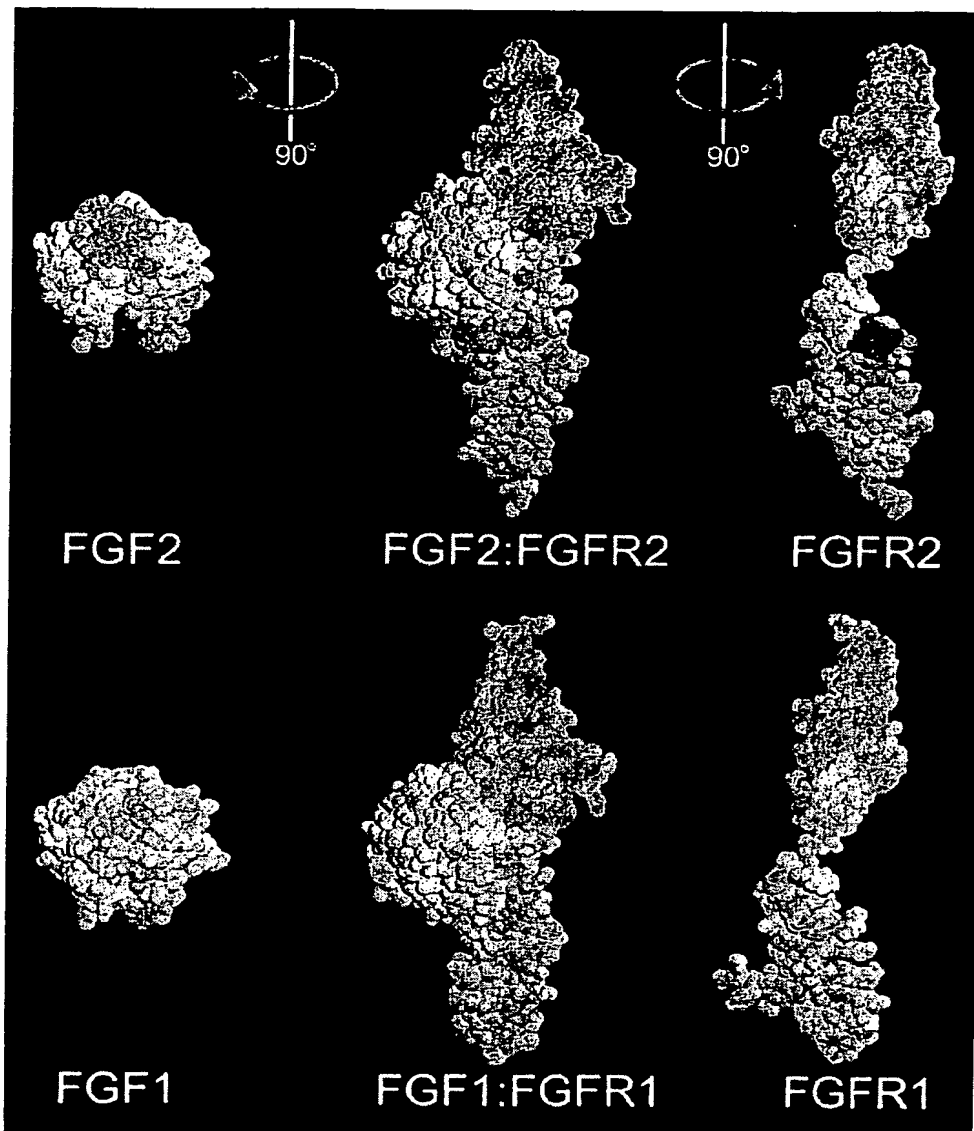
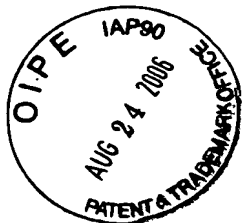

Figure 6

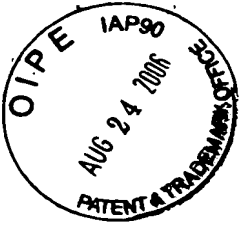

Figure 7

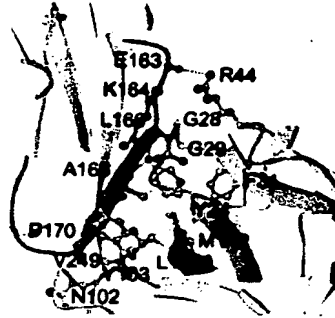
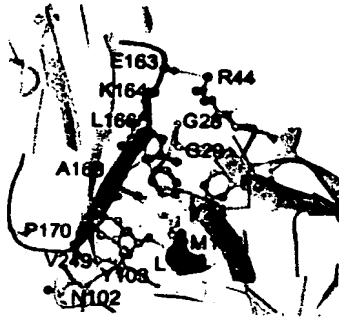

Figure 8

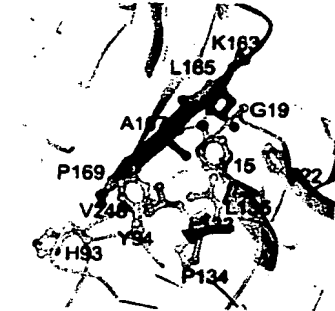
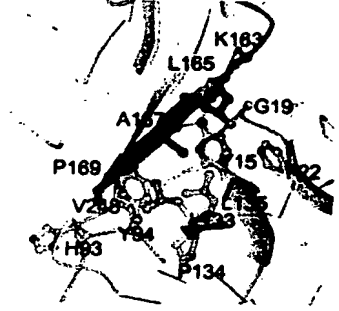

Figure 9

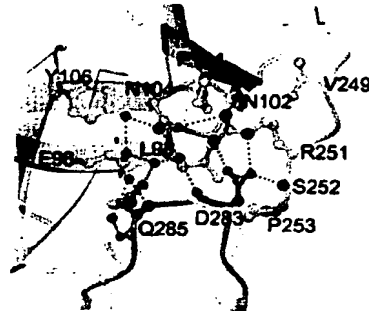
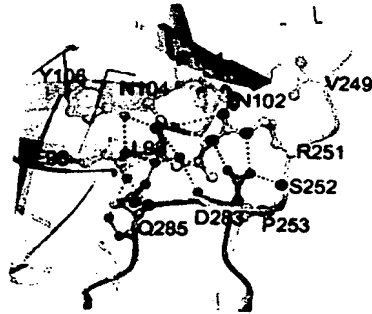
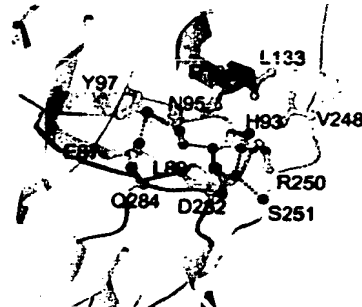
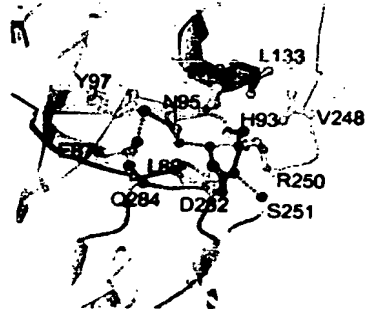

Figure 10



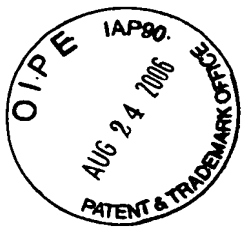

Figure 11

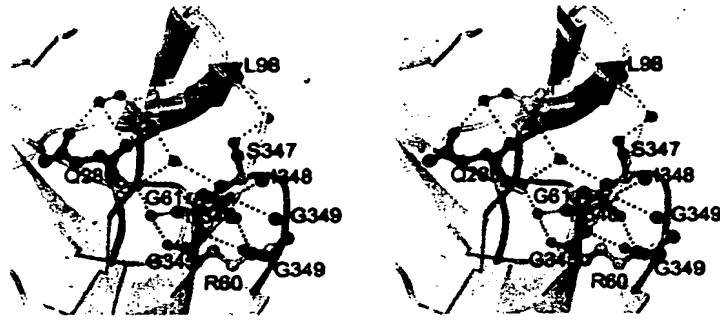

Figure 12

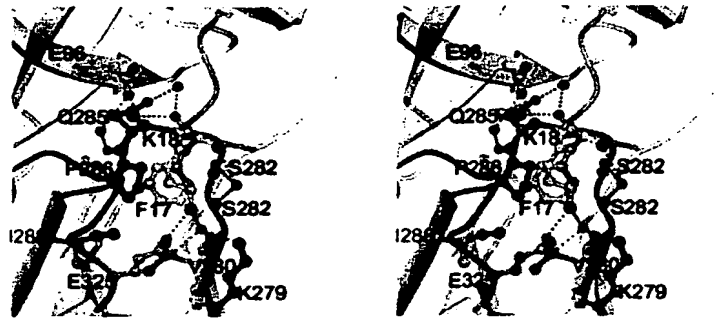

Figure 13

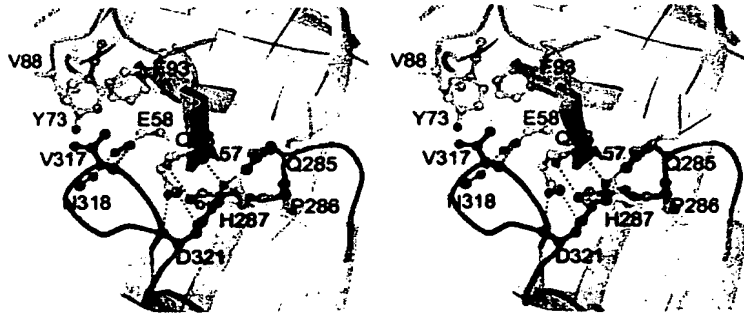
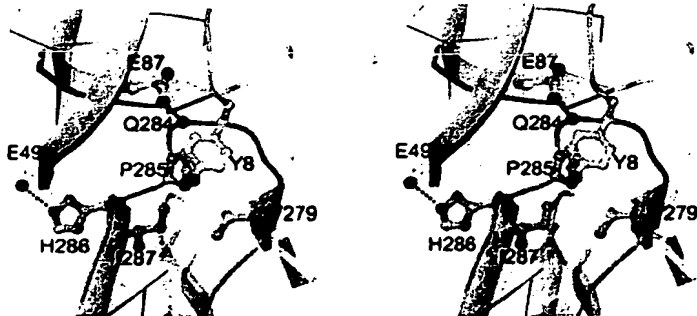
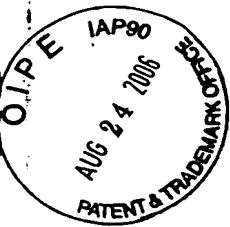

Figure 14





	bbbbA	gggA	bbbbA'	bbbB	bbbB'	bbbbbc	bc'
	150	160	170	180	190	200	
r1	MPV.....	SP.....	K.....	K....	K..SS	T.N..L.....	P
r2	NKR	APYWTNTEKMEKRLHAVPAANTVKFRCPAGGNPMPTMRWLKNGKEFKQ					
r3	DTG.....	RP.R.D.K.L.....	R.....	A...T	SIS.....	R..RG	
r4	PQQ.....	HPQR...K:.....	G.....	A...T..I.....	D.QA.HG		

	bbD	bbbE	bbbbbbbf	bbbbbbbbbG
	210	220	230	240 250
r1	D.....	YAT..I..D.....	I.....	Q.....
r2	EHRIGGYKVRNQHWSLIMESVVP	SDKGNITCVVENEYGSINHTYHLDVVERS		
r3	I.L.H.Q...V.....	R.....	KF...RQ..T...L...
r4	.N....	IRL.H.....V.....	R.T...L...AV...RYN.L...L...	

Figure 15

	ba	ba'	bbbB	bb'	bbbbbbbc
	260	270	280	290	300
R1 (IIIc)	KTVAL.SN...M.....	P.....	L..I.V.....	I...N.
R2 (IIIc)	PHRPILQAGLPANASTVVG	DVEFVCKVYSDAQPHIQWIKHVEKNGSKYGP	DGL		
R3 (IIIc)	QTA.L.S....H.....	L....	V....V....T	
R4	TTA...S...LL.....	L..IVI...SF	AV.F	
R1 (IIIb)	KTVAL.SN...M.....	P.....	L..I.V.....	I...N.
R2 (IIIb)				
R3 (IIIb)	QTA.L.S....H.....	L....	V....V....T	
R1 (IIIa)	KTVAL.SN...M.....	P.....	L..I.V.....	I...N.

	bbbbbbC'	bbbE	bbbbbbbf	bbbbbbbbbG
	310	320	330	340 350 360
R1 (IIIc)	..VQI..TM...HL...S.....	L.H.....	
R2 (IIIc)	PYLKVLKAGVNT	KEIEVLYIRNVTFEDAGEYTC	LAGNSIGISFHSAWLTVL	
R3 (IIIc)	..VT...T	...L...SLH.....	F.H....V..	
R4	..VQ...T	DISSSE--V...L...SA.....	L.YQ.....	
R1 (IIIb)	..VQI..HS	ISSS--A...TLF...EAQS...V.KVS.Y..EANQ.....	T	
R2 (IIIb)HS	ISSS--A...ALF...EA.....I.KVS.Y..QANQ.....		
R3 (IIIb)	..VT...T	SWISESVEADVR.RLA..SER.G...L.R.T.F..VAEKAF..S.H		
R1 (IIIa)	..VQI..VIMAPV	FVGQSTGKETT	VSGAQVPVGR	LSCPRMGSFLT

Figure 16



FGF1 *5 bbbb1 L...T...DR...Q...S...SV...E...Y...STETG...DT...L...Y...G...Q
FGF2 *14 bbbb2 F...L...H...P...D...G...V...E...K...S...D...H...I...K...I...O...L...A...M...K...E...D...R...L...L...A...S...K
FGF3 bbbb3 YH...QL...S...N...SL...N...-...AYS...I...E...I...T...V...I...A...R...L...F...S...G...N...K...R...Y...E
FGF4 77 bbbb4 H...Q...A...L...I...G...A...H...A...D...T...-...R...D...S...L...E...S...P...V...S...S...K...K...Y...G...P
FGF5 82 bbbb5 H...Q...Y...-...K...N...S...H...A...N...-...M...L...S...V...E...I...F...V...S...G...R...F...V...S...S...K...K...H...A
FGF6 79 bbbb6 H...Q...V...L...-...I...S...T...H...E...N...-...Y...S...L...E...I...S...T...S...L...F...R...S...A...L...F...V...N...S...K...Y...T...P
FGF7 60 bbbb7 W...Y...D...K...R...-...K...K...T...O...M...K...N...Y...N...I...M...E...I...R...T...V...A...V...I...A...E...S...E...F...V...N...K...K...Y...A...K
FGF8 65 bbbb8 K...H...V...O...L...A...N...-...I...N...A...M...A...D...G...F...A...I...V...E...T...D...F...S...R...V...R...A...E...T...G...L...I...C...N...K...K...I...K...S
FGF9 bbbb9 H...E...F...N...-...T...I...Q...T...K...D...H...S...R...F...G...I...E...F...I...S...I...A...V...L...S...R...D...S...G...L...G...N...K...E...Y...G...E
FGF10 73 bbbb0 Y...K...E...K...N...-...K...S...T...R...K...E...N...C...Y...S...I...E...I...T...S...V...I...L...R...A...Q...K...S...L...G...H...M...N...A...E...L...Y...S...P
FGF11 68 bbbb1 Y...Q...A...N...-...S...I...Q...T...P...D...T...S...S...F...T...H...E...N...I...P...V...L...R...A...Q...K...S...L...V...N...G...E...Y...Y...S...D
FGF12 70 bbbb2 Y...Q...M...-...T...I...T...K...D...E...N...S...D...Y...T...L...E...N...I...P...V...L...R...A...Q...Q...T...K...I...N...S...E...Y...Y...T...E
FGF13 66 bbbb3 Y...Q...M...-...T...I...T...K...D...E...N...S...D...Y...T...L...E...N...I...P...V...L...R...A...Q...Q...T...K...I...N...S...E...Y...Y...T...E
FGF14 68 bbbb4 Y...Q...M...-...A...L...T...K...D...D...S...T...N...S...T...L...E...N...I...P...V...L...R...A...Q...Q...T...K...I...N...S...E...Y...Y...T...E
FGF15 46 bbbb5 R...S...-...S...C...E...E...D...-...Q...N...E...R...N...L...E...F...R...V...A...L...K...-...T...I...A...D...S...S...V...C...S...A...D...K...I...Y...G...L...I
FGF16 56 bbbb6 H...E...F...N...-...T...H...T...H...D...H...S...R...F...G...I...E...F...I...S...I...A...V...L...I...S...R...D...S...G...L...G...N...R...E...Y...G...K
FGF17 48 bbbb7 K...H...V...O...V...T...-...R...I...S...A...T...A...D...G...N...K...F...A...I...V...E...T...D...F...S...R...R...A...S...E...K...I...C...N...K...K...I...G...K...P
FGF18 48 bbbb8 K...H...I...Q...V...L...-...R...I...S...A...R...G...D...G...K...Y...A...Q...I...V...E...T...D...F...S...Q...R...C...K...E...T...E...F...C...N...R...K...V...G...K...P
FGF19 38 bbbb9 R...A...-...V...C...A...G...Q...S...A...S...L...E...I...K...V...A...L...R...-...T...A...H...S...V...C...G...A...D...K...M...O...G...L...L

FGF1 bbbb8 T-PNE...L...L...E...H...I...K...H...A...E...K...N...-...F...G...K...N...S...C...R...-...P...R...H...Y...L...P...V...S...D
FGF2 87 bbbb9 C-TDEC...F...R...L...E...S...N...-...M...Y...R...S...R...K...Y...T...S...-...W...V...A...L...K...R...T...G...Y...K...I...G...-...S...K...T...G...P...G...O...K...A...I...F...S...A...K...S
FGF3 110 bbbb0 H-YSA...E...V...I...H...E...L...G...-...A...L...R...T...V...S...T...P...G...A...R...Q...P...S...A...E...R...L...S...V...N...G...K...R...P...R...-...F...R...T...S...S...R...V...L...D...H...R...D...H...~
FGF4 150 bbbb1 F-F...T...M...I...L...P...-...A...E...Y...P...G...-...M...F...I...S...K...N...K...T...K...-...N...R...V...S...T...M...V...T...H...R...A...L
FGF5 155 bbbb2 K-F...D...K...R...F...O...E...S...-...A...A...I...H...R...E...K...T...G...-...R...E...N...K...R...K...A...R...C...S...P...R...V...K...Q...H...I...S...T...H...R...F...K...O...E...Q...P...-
FGF6 152 bbbb3 S-FQE...K...P...T...L...P...-...A...E...D...L...Q...G...-...T...I...S...K...Y...R...V...R...-...V...S...I...M...T...V...T...H...I...S...R...I
FGF7 132 bbbb4 E-CNED...N...K...L...I...L...E...H...-...A...A...W...T...H...N...G...G...E...-...M...F...M...F...T...K...R...P...R...K...K...E...T...A...H...A...I...T
FGF8 139 bbbb5 NGKGD...V...T...I...V...L...E...-...T...A...L...O...N...A...K...E...G...-...M...F...T...K...R...P...R...K...-...R...O...H...R...E...V...H...M...K...R...L...P...R...G...H...H...T...-
FGF9 129 bbbb6 K-LTQ...V...R...Q...F...E...M...-...S...N...L...K...H...V...D...T...G...-...R...R...Y...-...N...K...D...T...P...R...E...-...T...R...K...R...H...F...T...H...R...P...D...P...D...K...V...-
FGF10 145 bbbb7 E-FNND...K...L...K...I...E...C...-...A...F...N...M...O...H...N...G...R...O...-...M...-...N...G...K...A...P...R...R...-...Q...R...R...K...N...T...S...A...H...V...H...
FGF11 140 bbbb8 H-F...A...R...K...C...V...E...Y...-...V...L...A...A...L...R...O...R...R...S...G...-...R...A...L...G...D...K...E...V...M...K...-...N...R...V...K...T...K...A...A...H...K...L...L...E...V...A...M...Y...-
FGF12 142 bbbb9 V-F...P...K...K...S...V...F...E...Y...-...V...I...S...T...L...R...O...Q...E...S...G...-...R...A...F...L...G...N...K...E...I...M...K...-...N...R...V...K...T...K...P...E...S...H...V...K...P...I...E...V...C...M...Y...-
FGF13 138 bbbb0 L-F...P...K...K...S...V...F...E...Y...-...V...I...S...M...I...R...O...Q...O...S...G...-...R...G...L...G...N...K...E...I...M...K...-...N...H...V...K...N...K...P...A...H...K...P...L...K...V...A...M...Y...-
FGF14 140 bbbb1 L-F...P...K...K...S...V...F...E...Y...-...V...I...S...M...L...R...O...Q...E...S...G...-...R...A...F...L...G...N...K...E...I...M...K...-...N...R...V...K...T...K...P...A...H...K...P...L...K...V...A...M...Y...-
FGF15 121 bbbb2 RYSEED...T...R...E...M...D...C...L...G...-...Q...R...M...H...L...H...-...I...I...F...I...O...A...P...R...E...L...Q...D...Q...-...P...S...N...I...D...V...F...H...R...F...F...E...-
FGF16 128 bbbb3 K-L...R...V...R...Q...F...E...M...-...T...A...F...O...N...A...R...H...E...G...-...R...O...Y...-...N...K...D...S...P...R...E...-...Y...R...K...R...H...F...T...H...R...P...D...P...S...K...L...-
FGF17 121 bbbb4 DGTSK...V...I...K...V...L...E...-...T...A...L...M...A...S...G...-...F...M...F...T...O...R...P...R...O...A...-...R...S...R...O...N...R...E...A...H...I...K...R...L...Y...O...G...O...L...P...-
FGF18 121 bbbb5 QYSEED...A...E...E...I...R...P...D...G...-...I...V...-...E...H...R...-...L...P...S...S...S...A...K...R...Q...Y...-...N...R...G...F...L...F...L...S...H...L...P...M...V...P...E...E...-
FGF19 114 bbbb6

Figure 17

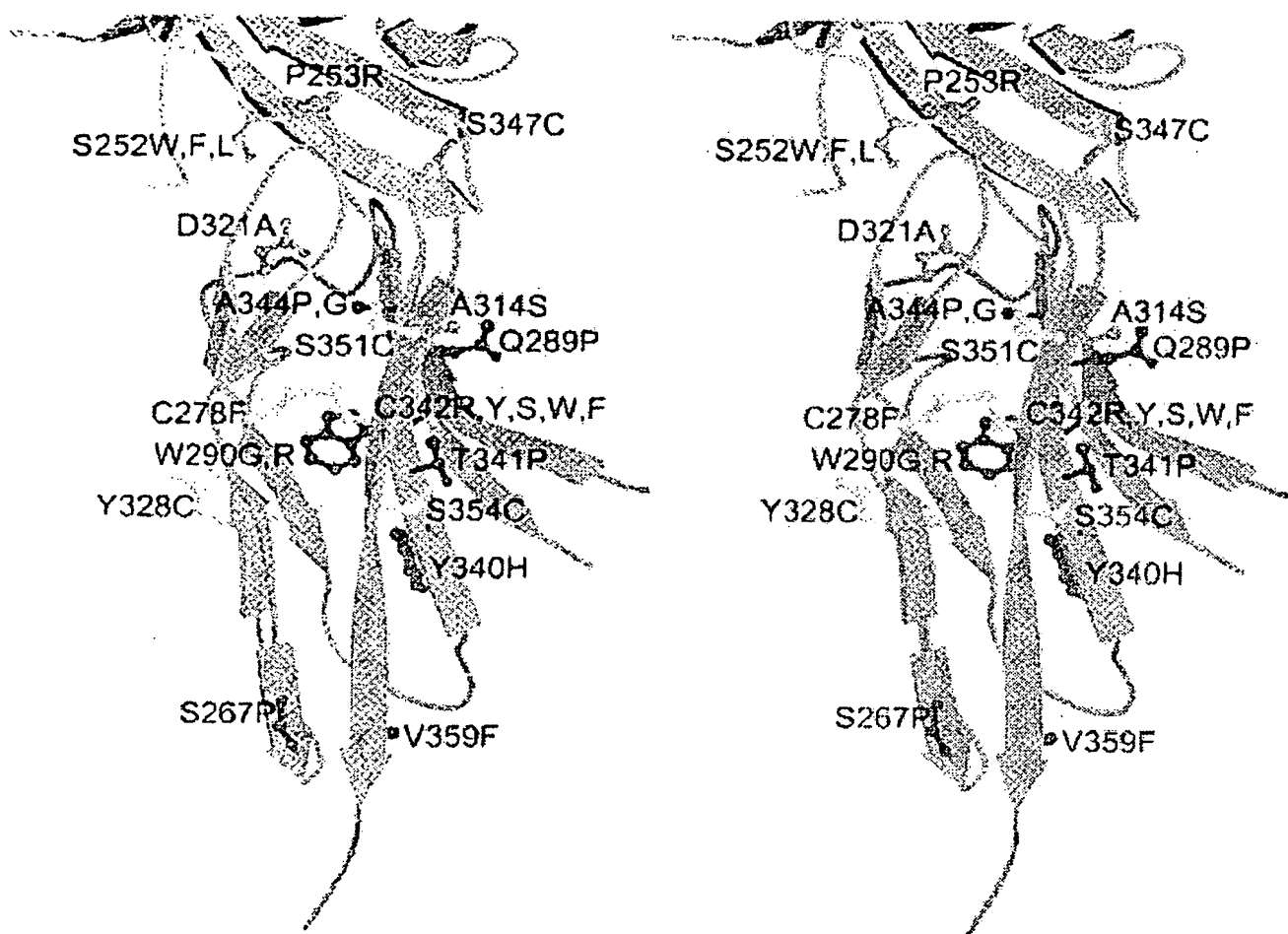

Figure 18

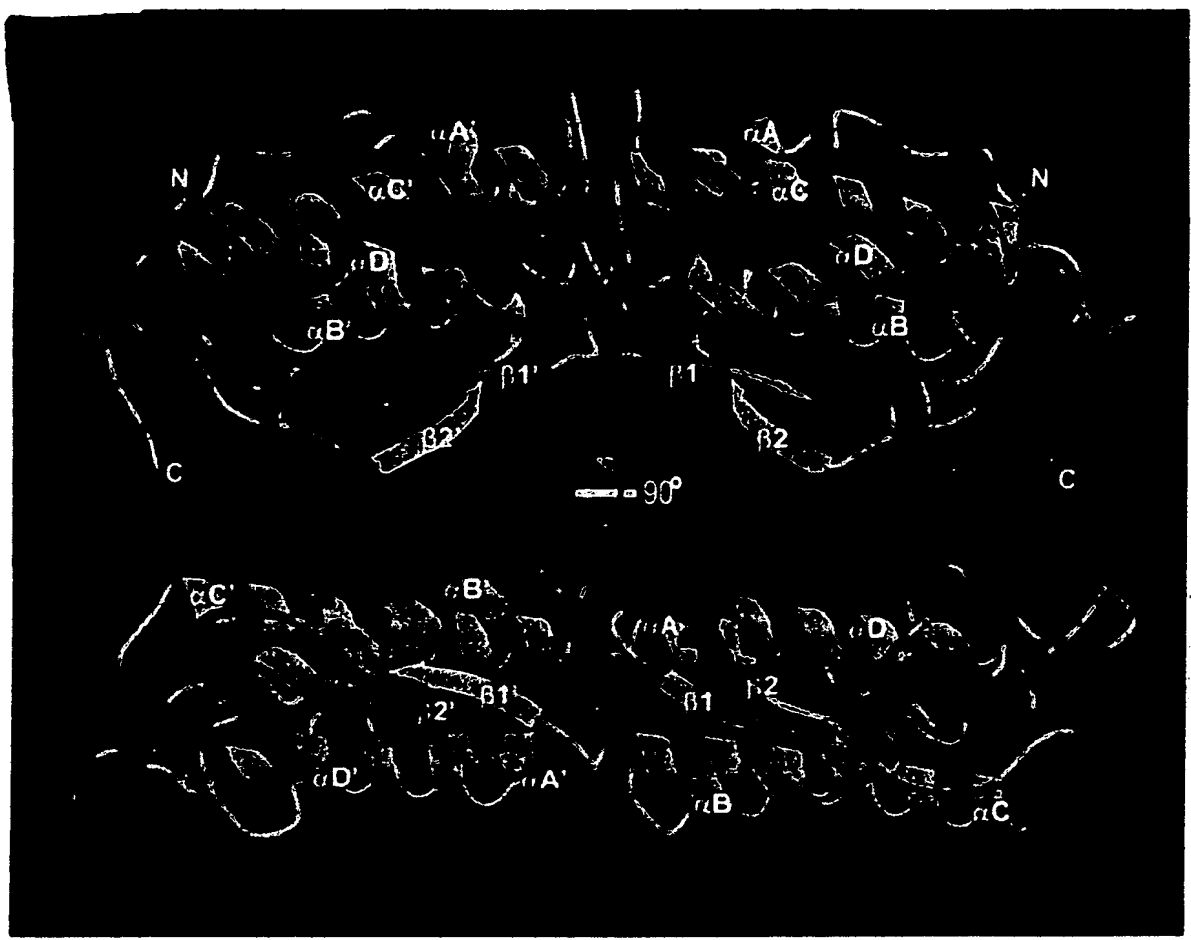
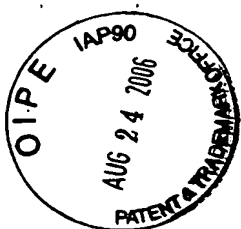

Figure 19



```

      A                     1
SCF      EGICRNEVTED[REDACTED]ALPKDYM--ITLKIVPGMDVL-
M-CSF    SE[REDACTED]IG[REDACTED]SOMETSCQITPFVQDEQLKD
IL-5     IP[REDACTED]NETL--RIPV[FVHK]N-----

      B                     C
SCF      PSHCN[REDACTED]OKPSNISEGLS[REDACTED]NSSKDL
M-CSF    -[REDACTED]NT[REDACTED]SCTEDY-----
IL-5     [REDACTED]IVQ---GC[REDACTED]GE-----

      2                     D
SCF      KKSFKSPEPRLETT---P[REDACTED]DAFKDF---VVASETSDCVVS
M-CSF    EEHDKAC VRTFYET-[REDACTED]DWHIFSKNCNNSFAECSSQGH
IL-5     -----ERRR---V[REDACTED]-----EWI

```

Figure 20

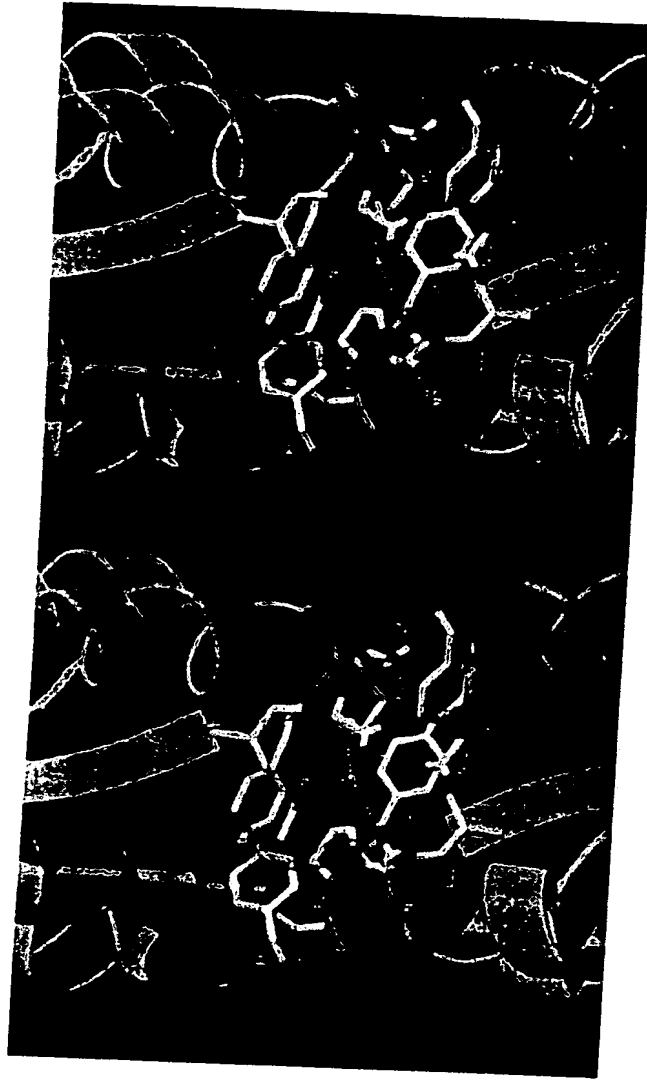
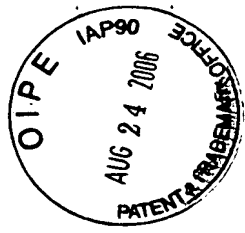

Figure 21



U.S. Application No. 10/049,429
Inventors: Joseph SCHLESSINGER et al.
Title: CRYSTAL STRUCTURES ... THEIR LIGANDS
Attorney Docket No. 034536-0574
Replacement Sheet 15 of 26

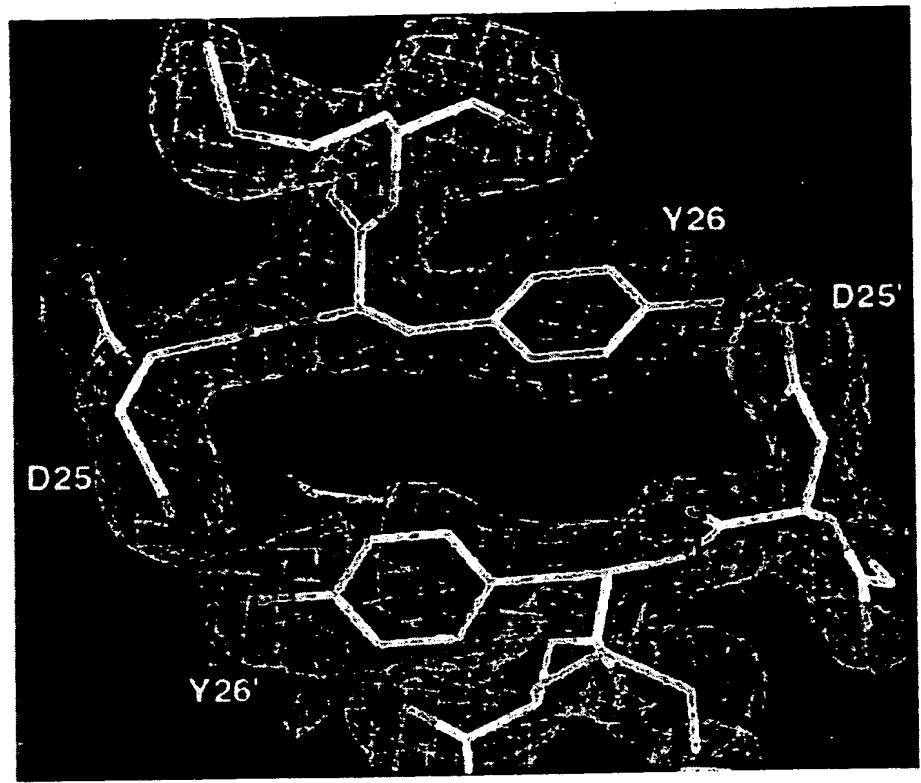

Figure 22

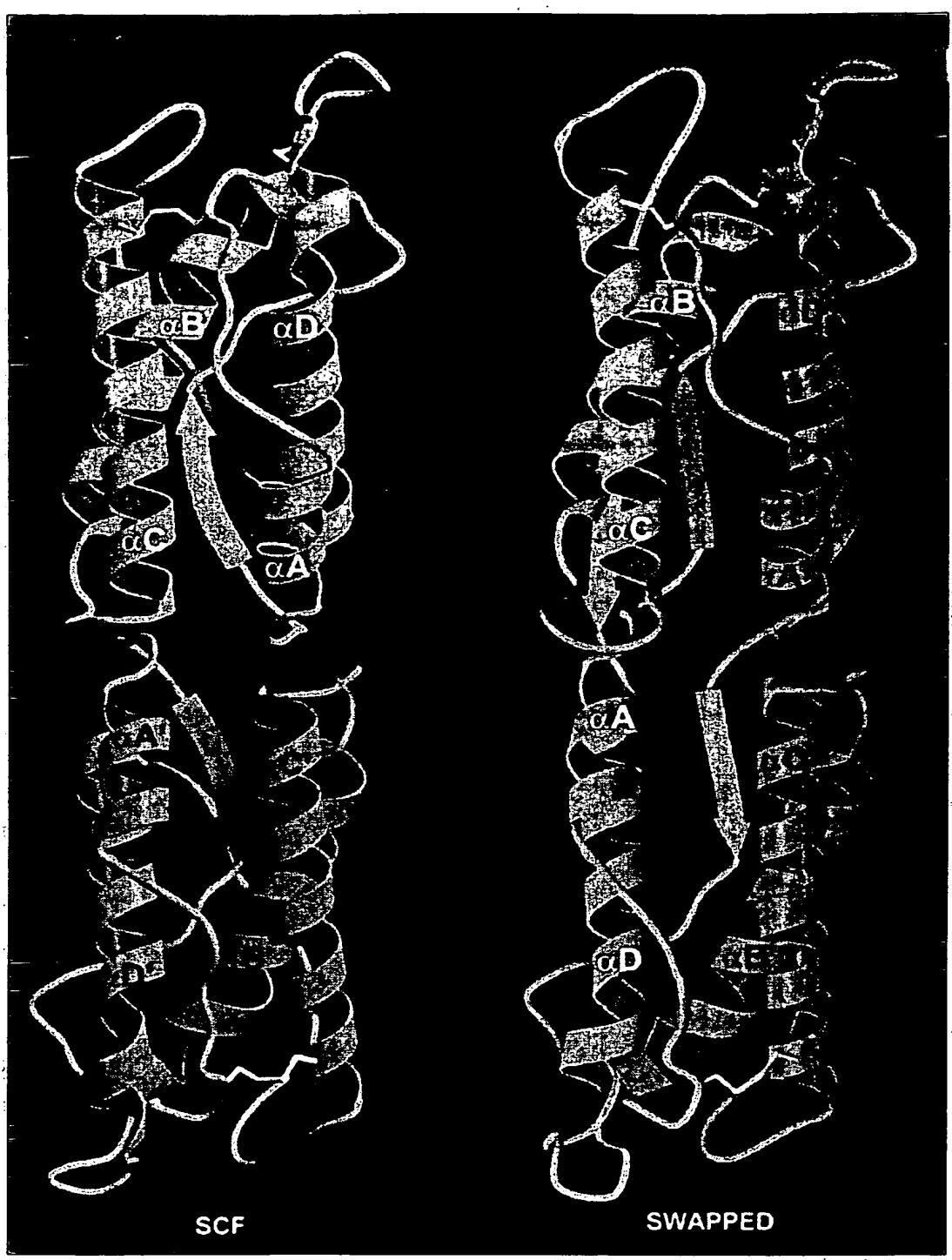
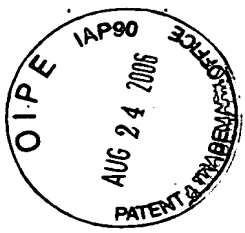

Figure 23

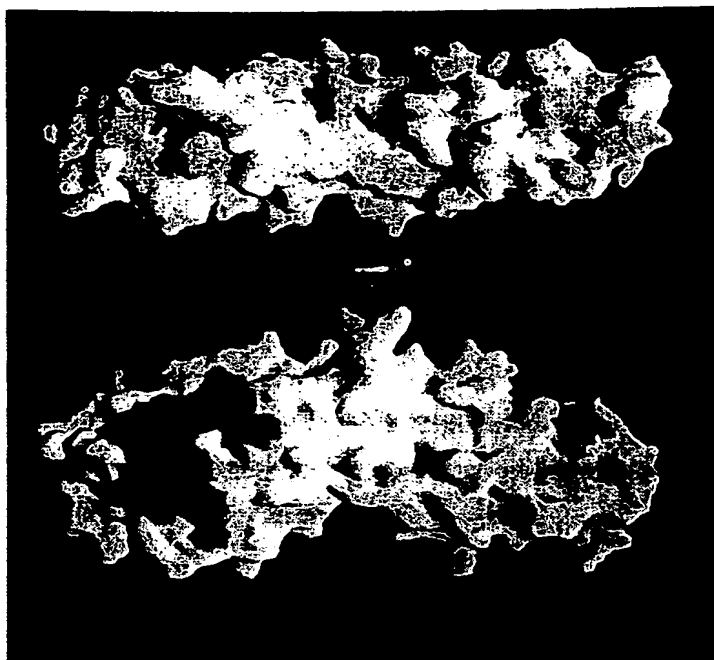
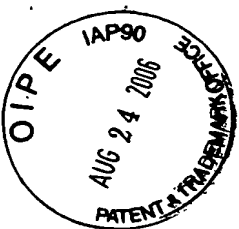
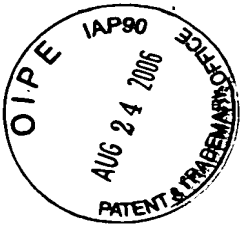

Figure 24



human	EGIC	VTNNV	KDVTKL	VANL	PKDYMITL	KYVPGMDVLP	SHCWISEM	VVQLSD	SLTDLL							
rat	QEIC	VTDNV	KDIT	TKLVANL	PNDYMITL	NYVAGMDVLP	SHCWLRDM	VTHLSV	SLTLL	*						
mouse	KEIC	VTDNV	KDIT	TKLVANL	PNDYMITL	NYVAGMDVLP	SHCWLRDM	VIQI	SLSLTLL	*						
dog	KGIC	VTDV	KDVT	TKLVANL	PKDYKIAL	KYVPGMDVLP	SHCWIS	WVEQL	SVSLTDLL							
pig	QGIC	VTDV	KDVT	TKLVANL	PKDYKIAL	KYVPGMDVLP	SHCWISEM	VEQL	SVSLTDLL							
SS					HHHHHHHH	EEEE	HHHHHHHH	HHHHHHHH	HHHHHHHH							
human																
rat	RSIDAF	DF	-VVAS	ETS	DCVVS											
mouse	RSIDAF	DF	-MVAS	DT	SDCVLS											
dog	RSIDAF	DLE	VASK	S	S	ECVVS										
pig	RSIDAF	DLE	VAPK	T	S	ECVIS										
SS	HHH														
human	DKFSNISE	EGLSNYS	IIDKLV	NIV	DLV	CV	ENSSKDL	SF	SPE	RFTPEE	FRIEN					
rat	DKFSNISE	EGLSNYS	IIDKLV	GLV	LV	CM	ENAPKNV	SI	KPE	T	RNF	TPEE	FFSIFN			
mouse	DKFSNISE	EGLSNYS	IIDKLV	GLV	LV	CM	ENAPKNI	SP	RPE	T	R	S	F	TPEE	FFSIFN	
dog	DKFSNISE	EGLSNYS	IIDKLV	KIV	L	V	CT	YS	FENV	AD	SPE	R	L	F	TPEE	FFRIFN
pig	DKFSNISE	EGLSNYS	IIDKLV	KIV	L	V	CM	HS	FENV	SS	SPE	R	L	F	TPEE	KEFGIFN
SS							HHHHHHHH	HHHHHHHH	EEEE	HHHHHHHH						

Figure 25



U.S. Application No. 10/049,429
Inventors: Joseph SCHLESSINGER et al.
Title: CRYSTAL STRUCTURES ... THEIR LIGANDS
Attorney Docket No. 034536-0574
Replacement Sheet 19 of 26

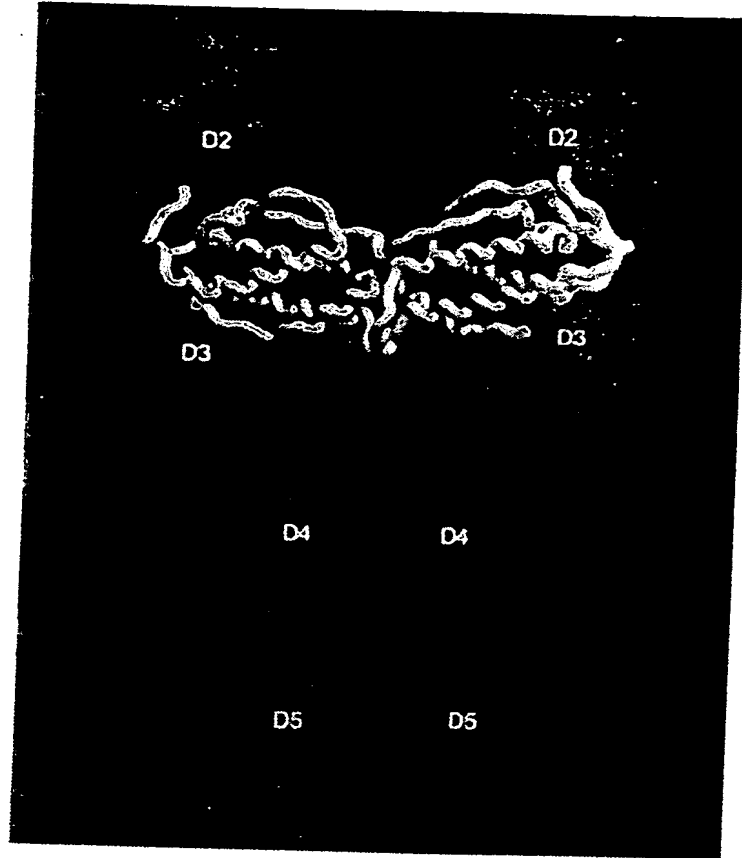

Figure 26

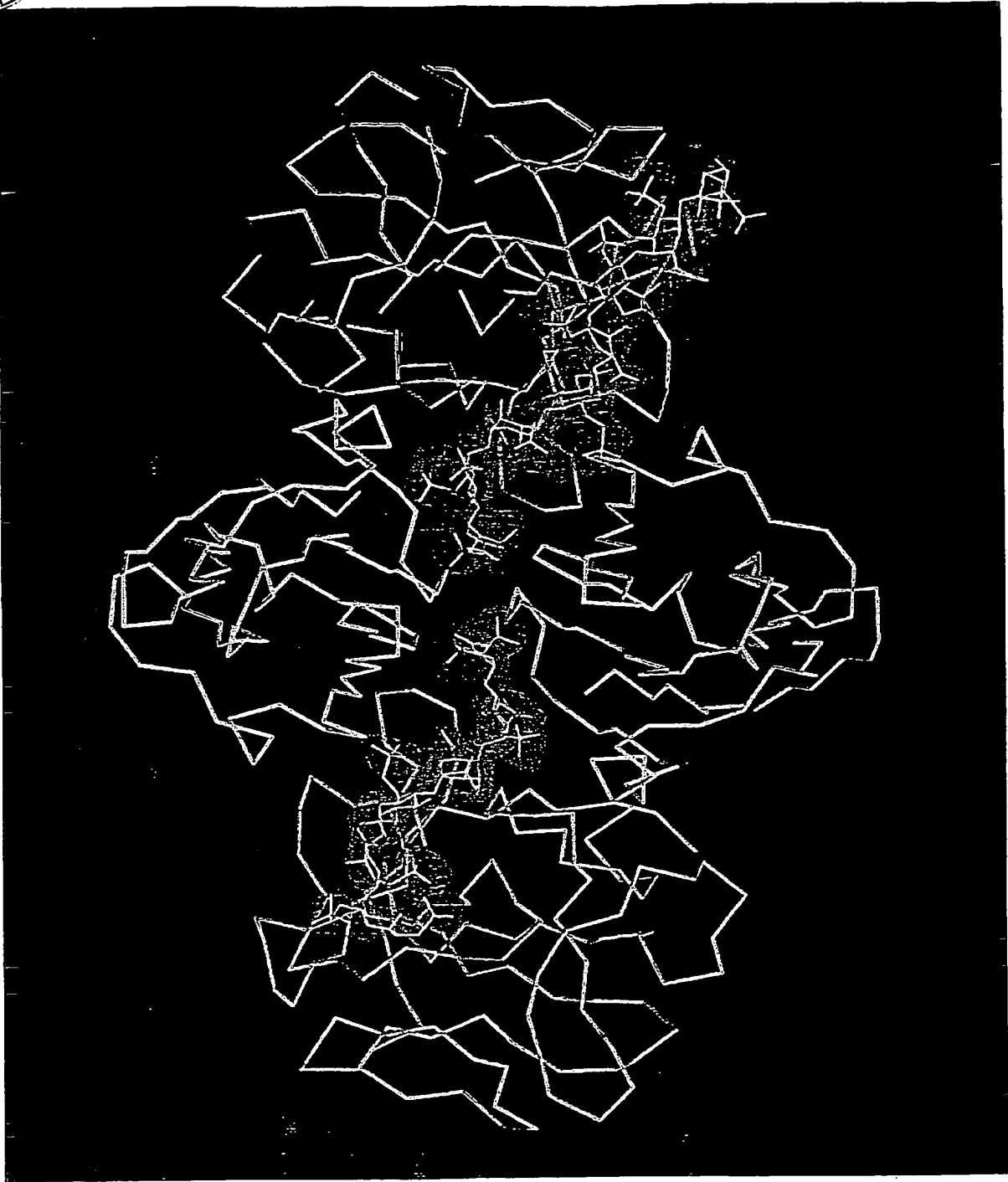
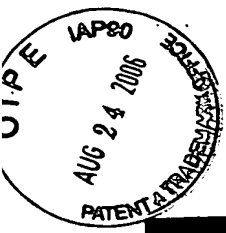

Figure 27

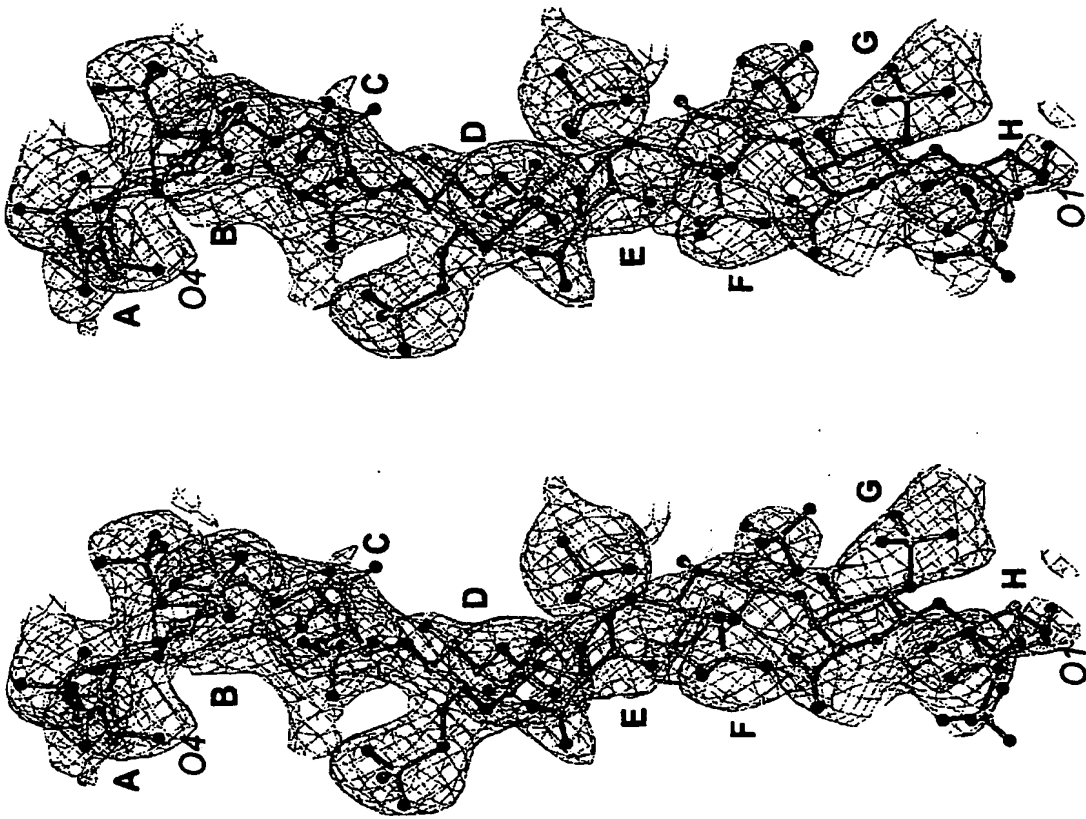
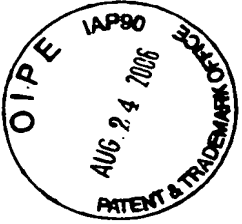

Figure 28

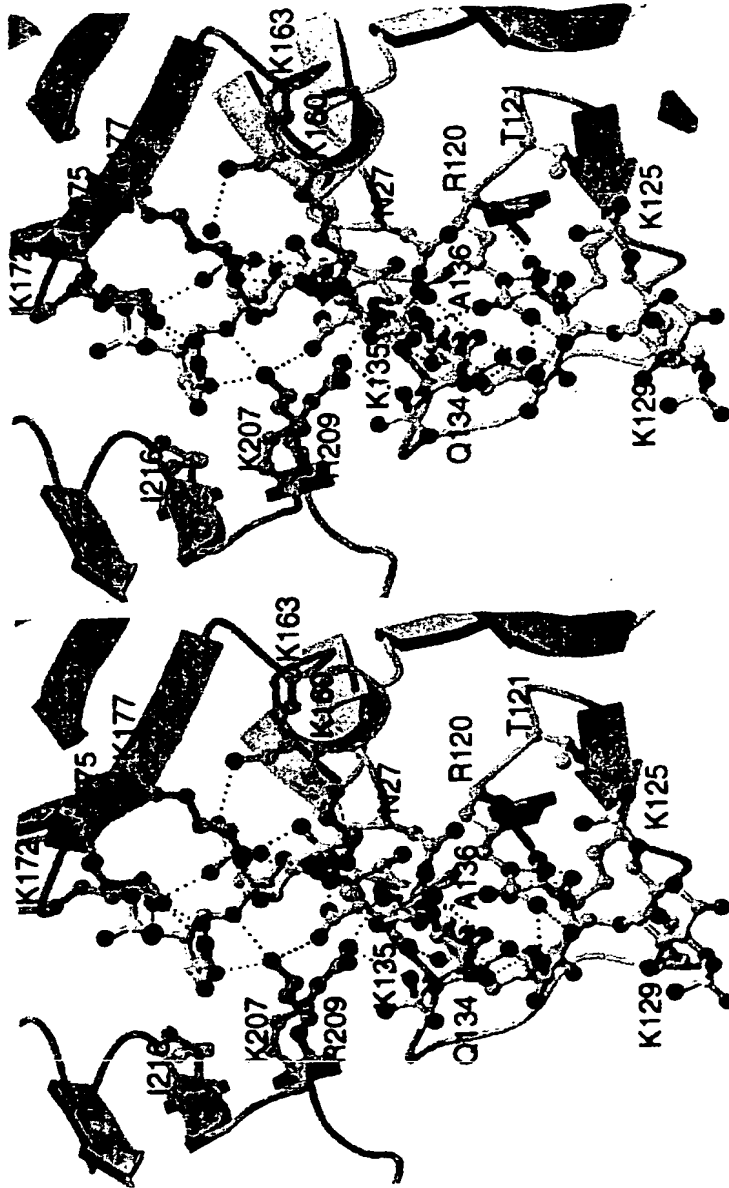

Figure 29

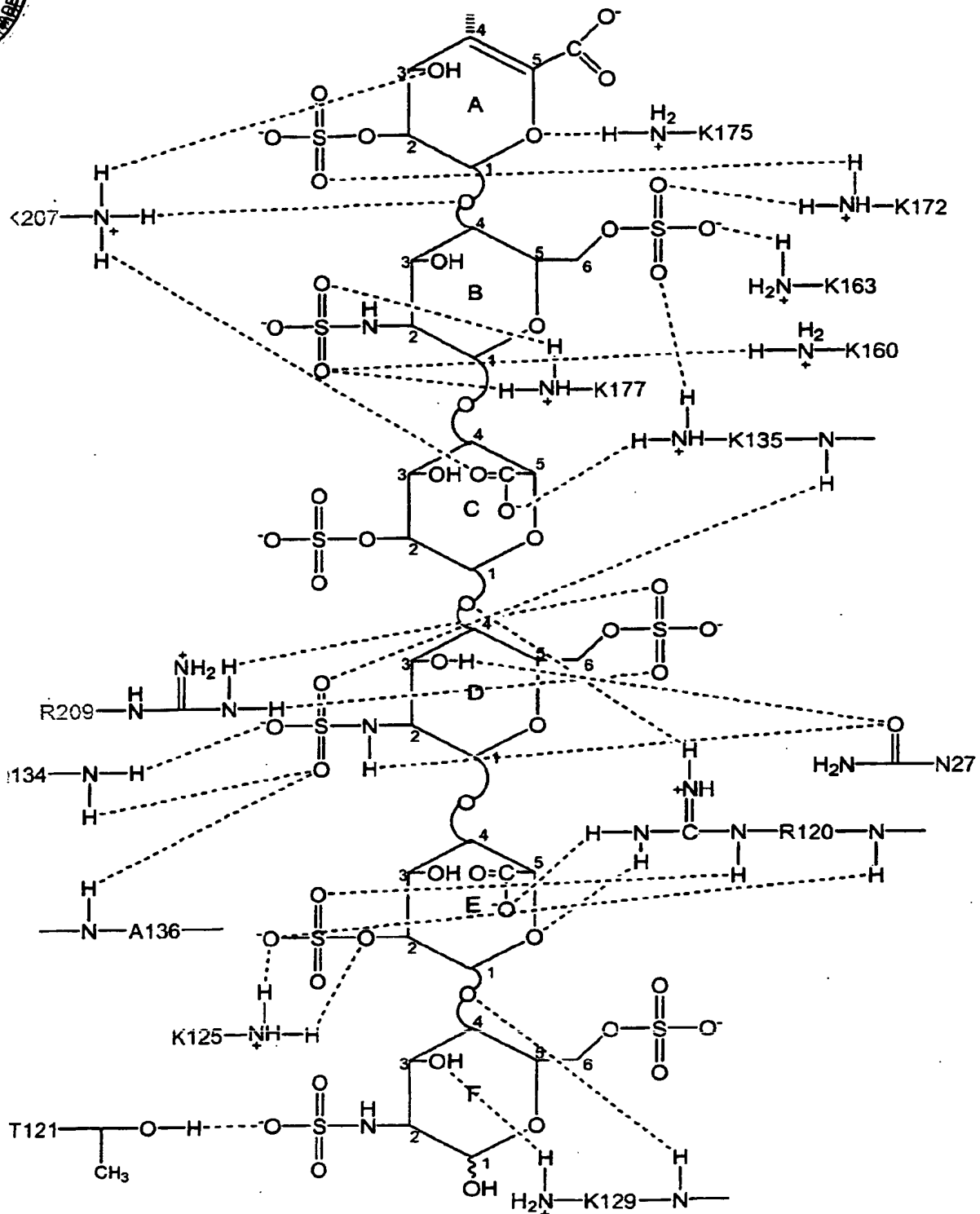
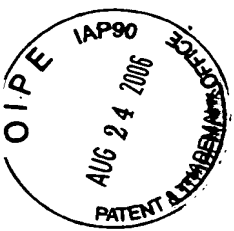

Figure 30

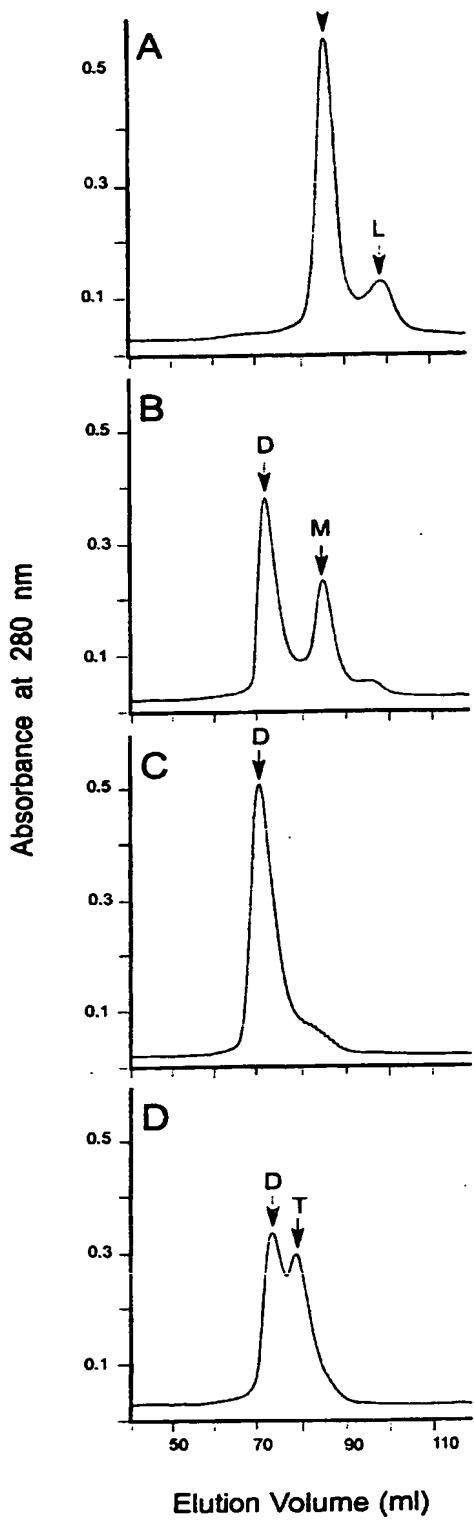

Figure 31

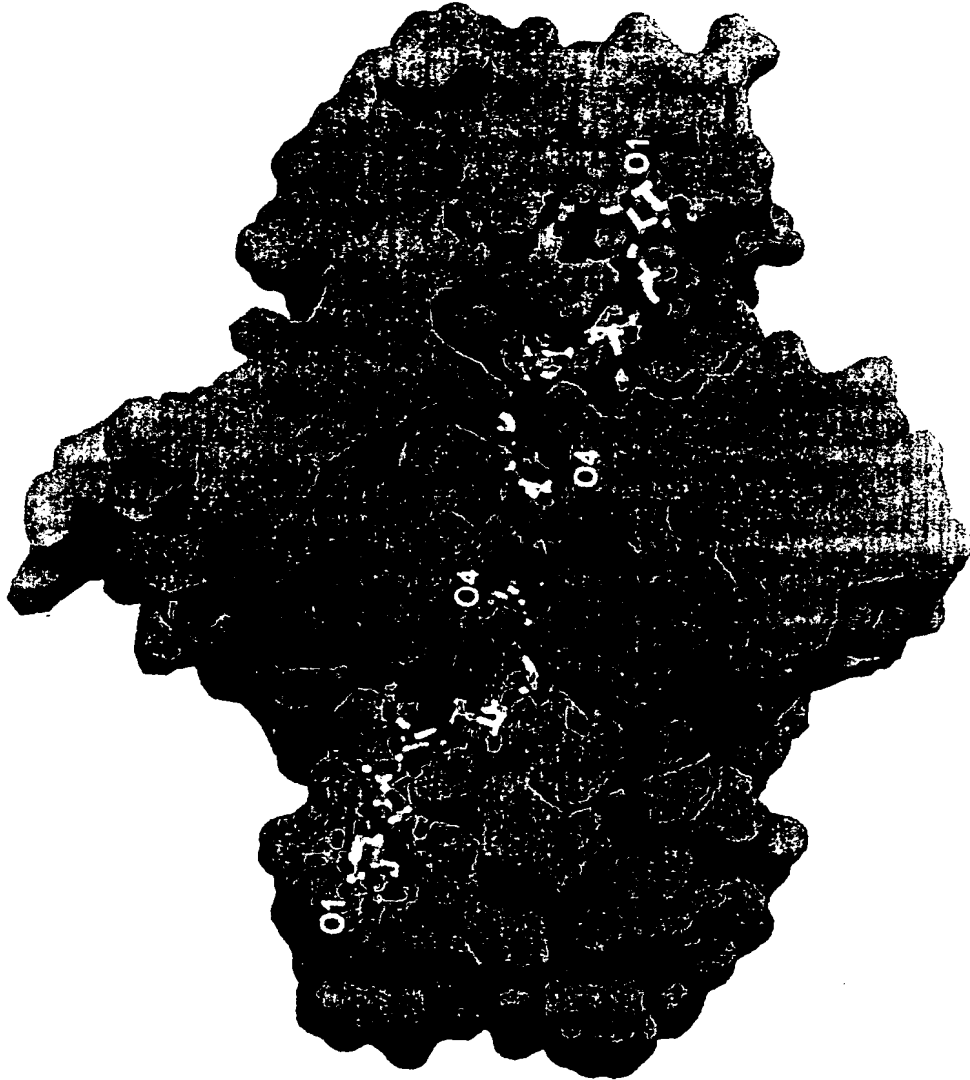

Figure 32

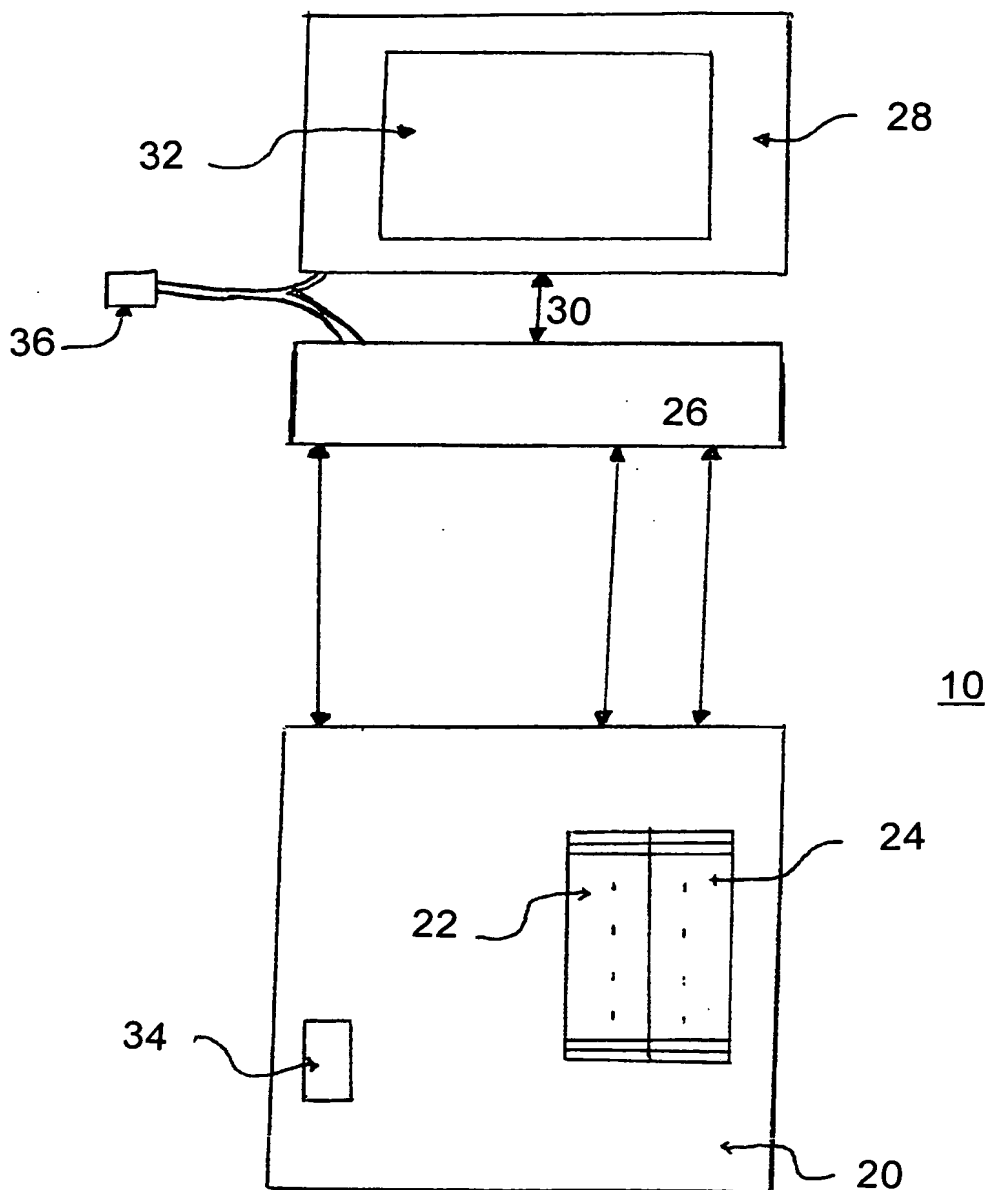
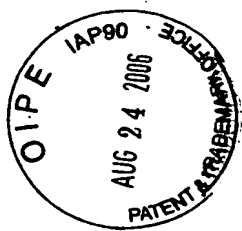

Figure 33